

HYDROTITE

General Building Authority Test Certificate



Properties:

HYDROTITE is a water-expandable rubber on a polychloroprene basis (CR=chloroprene rubber, neoprene), that is produced from chloroprene by radical emulsion polymerisation.

HYDROTITE, available in many different profile types, is used as a plastic sealing material in structural and civil engineering as well as in tunnelling.

The expanding property results from the irrevocable bonding of polyurethane-based water-expandable polymer resin with the CR matrix by vulcanisation. *HYDROTITE* can expand up to 1300 vol.% by absorbing water, whereby the CR-matrix provides for strength of shape during the expanding process.

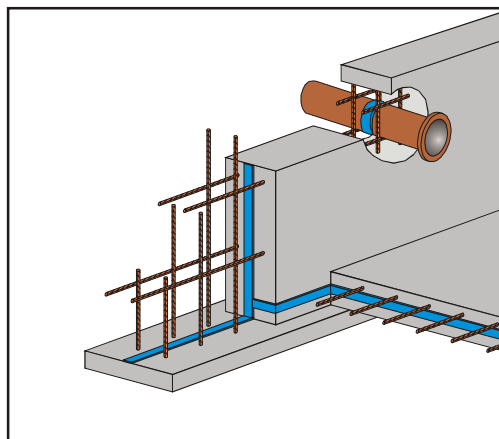

HYDROTITE is used for the sealing of construction joints, renovation of expansion joints, sealing of precast concrete component panels, tubing segments in tunnelling, the sealing of shaft rings and pipe lead-throughs etc.

Technical data:

Rubber type	solid rubber
Material basis	polychloroprene, vulcanised
Colour	blue (other colours on request)
Spec. density (20°C)	approx. 1.4 g/cm ³

Profile types

square, humped, round, air chamber profiles

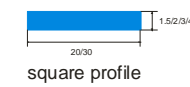

square profile

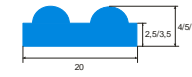

humped profile



CJ profile



round profile



round profile with non-swelling neoprene core

Shore A hardness	approx. 50	DIN ISO 7619-1
Tensile strength	approx. 3,0 MPa	DIN EN ISO 527
Elongation at break	approx. 600 %	DIN EN ISO 527
Water absorption	approx. 800 -1300 Vol.%	* DIN EN ISO 62
Delay coating	yes	

* depending on profile type (CJ profile = 800 Vol.%)

Processing:

Sealing of construction joints:

For a successful application of *HYDROTITE* in construction joints, the selected profile is placed with its cross-section in centre or at a distance of 10 cm to the nearest concrete edge and bonded over its full surface to the existing concrete with *FIX-O-FLEX* or *QUELLFLEX*. It may also be nailed to aid bonding (or as an alternative). It has to be sure that the profile cannot change its position while concreting.

Rough surfaces should be smoothed before adhering the profile. We recommend the use of *QUELLFLEX*. It develops in contact with water quickly the necessary pressure and supports like this profile.

In case of damp concrete the use of *FIX-O-FLEX* is a must. Joints and lap-over parts are fixed by means of *QUELLFLEX*.

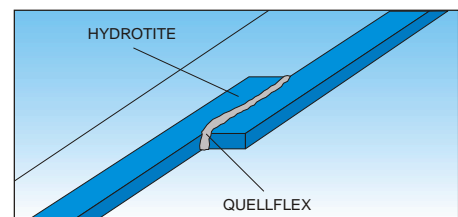
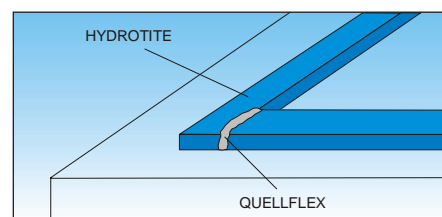

The application of *HYDROTITE* should be carried out in dry weather conditions if possible or shortly before concreting.

Due to the factory-applied delay coating it is possible to expose the product unprotected to wet weather conditions for maximum 2 to 3 days.

If longer periods between application and concreting under wet weather conditions are expected the profile must be coated with *HF-KLEBER* to avoid premature swelling.

Such a water-expanding rubber profile coated with *HF-KLEBER* may be exposed to wet weather conditions without swelling for approximately 7 days.

Restoration of expansion joints:

HYDROTITE round profiles with neoprene cores are driven into the joint that was cleaned out beforehand by means of wedges or an adequate compressed-air chisel. Remember to choose a profile diameter that will allow sufficient contact pressure with the material when you drive in the profile.

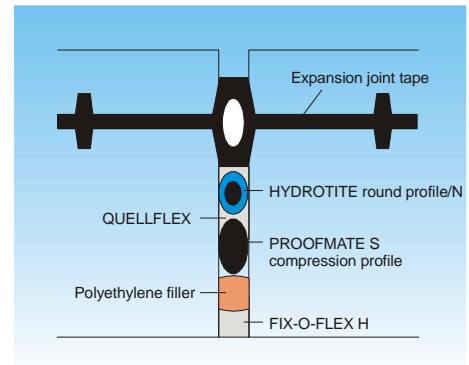

Ensure that the material is well insulated on all sides (styrofoam board) so that an adequate expanding pressure can build up in the case of water bearing stratum.

The joint should be completed with a permanently elastic seal such as e.g. *FIX-O-FLEX H* or *FIX-O-FLEX VG*.

Sealing of precast concrete elements:

At use of *HYDROTITE* for sealing of precast concrete elements it is recommended to create a notch in the elements.

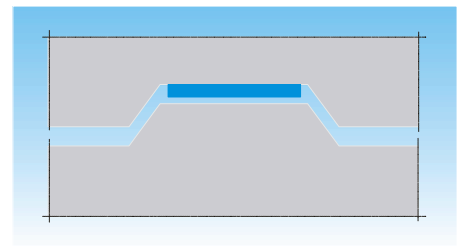

The applied profile is chosen so that the elements create already at assembling a pre-stress. A proper plugging by means of mounting cements like *F60* / *F300* or permanently elastic sealants e.g. *FIX-O-FLEX H* or *FIX-O-FLEX VG* can be achieved.

Safety information:

No special measures required

Packaging:

Rolls in carton

Packaging depending on profile type, see price list

Storage:

Shelf life at least 24 month in original packaging when stored in dry conditions between 15-25°C, protected from heat, frost and direct sunlight.

After the expiration the use of the product is generally not recommended, unless an approval has been provided by TPH. This approval can only be obtained by the quality assurance department of TPH releasing the material after verification of main properties being within specification.

Disposal:

Recommendation:

Small quantities of product residues can be disposed of as normal domestic waste. Dispose of bigger quantities must be effected in accordance with the corresponding local regulations.



Test certificates:

Technical application test of *HYDROTITE* humped profile RS 0520-3.51; STUVA Köln 1985

Technical application test of *HYDROTITE* round profile RSS 160 P with temporary support by means of an elastomeric compression profile; STUVA Köln 1985

General Building Authority Test Certificate for *HYDROTITE* water-expanding rubber profile; MFPA Leipzig 2006

Swelling behavior of *HYDROTITE* in contact with fluids with different pH values; MFPA Leipzig 2006

Resistance test of *HYDROTITE* to sewage, liquid manure and silage effluent; MFPA Leipzig 2006

Determination of the effects of liquids according to DIN ISO 1817 with various de-icing agents and kerosine; MFPA Leipzig 2008

Legal notice:

The correct and thus successful application of our products is not subject to our control. A guarantee can be issued for the quality of our products within the framework of our sales and supply conditions, however not for successful processing. All data and specifications in this specification sheet are based on the present state of the art and the right to changes and adaptations for the sake of development remains explicitly reserved. The consumption specifications designated by us can be only average empirical values, where deviations are possible on an individual basis and therefore cannot be excluded by us.

TPH Bausysteme GmbH
Nordportbogen 8
D-22848 Norderstedt

Tel.: +49 (0)40 / 52 90 66 78-0
Fax: +49 (0)40 / 52 90 66 78-78
e-mail info@tph-bausysteme.com
Web www.tph-bausysteme.com

